



# *Ultrasonic Air Sensors*

## *Operators Manual*





# TERUMO

## Ultrasonic Air Sensors

REF /Catalog No.	Color	Tube Size
5785	Black	1/4 in. (6,4 mm) ID x 1/16 in. (1,6 mm) wall
5791	Gold	1/4 in. (6,4 mm) ID x 3/32 in. (2,4 mm) wall
5773	Red	3/8 in. (9,5 mm) ID x 3/32 in. (2,4 mm) wall

### Cautions

Federal (U.S.A.) law restricts this device to sale, distribution and use by or on the order of a physician.

It is the user's responsibility to use, check, and maintain this device according to the labels of the product, accompanying instruction manuals, and any revisions of the labeling or instructions that may be subsequently issued.

### Service Policy

Only Terumo Cardiovascular Systems Corporation certified service technicians are authorized to service or repair this device. Only Terumo Cardiovascular Systems Corporation approved replacement parts may be used in this device. Terumo Cardiovascular Systems Corporation approved parts are only available through Terumo Cardiovascular Systems Corporation certified service technicians. Any service or repair by an unauthorized service technician or use of unapproved parts will void your Terumo Cardiovascular Systems Product Warranty and may increase the risk of a product failure.

Contact Terumo Cardiovascular Systems Corporation Service, your local Terumo company or your authorized distributor for technical assistance and to arrange for service.

If the device is to be returned, instructions will be given for returning the device and a Returned Goods (RG) number will be issued. For contaminated devices, request the appropriate Product Return Safety Pack. Returned devices must be packaged with adequate protection against shipping damage. Include a note describing the problem, stating the RG number, and giving the name, address, and telephone number of a person to contact for additional information.

In the United States, contact the Terumo Cardiovascular Systems Corporation Technical Support Department:

Terumo Cardiovascular Systems Corporation  
6200 Jackson Road, Ann Arbor, Michigan 48103 U.S.A.  
Telephone: (800) 441-3220 Facsimile: (734) 741-6449

Outside the United States, please contact your local Terumo company, your authorized distributor or the Technical Support Department at Terumo Cardiovascular Systems Corporation.

Telephone: (734) 663-4145 Facsimile: (734) 741-6449

Europe: Technical Support - Medical Electronics - Call Free Number from:

AT 0800-293711	BE 0800-94410	DK 808-80701
FI 0800-115226	IE 1800-553224	CH 0800-563694
FR 0800-908793	IT 800-785891	GB 0800-9179659
DE 0800-1808183	NL 0800-0222810	NO 800-12270
GR 00800-3212721	ES 900-963251	SE 020-791373

Other countries call +32 16 381204 at international rates

E-mail: meservice@terumo-europe.com Fax: +3216381420

**Using this Manual** Read these instructions carefully: the warnings, specifications, set-up, test procedure and use for an ultrasonic air sensor may differ slightly between heart lung systems.

The Description section pertains to all heart lung systems, while the rest of the instructions are divided according to specific heart lung systems.

Place these instructions in the operators manual of the applicable system. If you move the ultrasonic air sensor to a different system, move these instructions also.

## Table of Contents

### **Description**

- 4 Indications
- 4 Contraindications
- 4 User Qualifications
- 5 Warnings
- 5 Equipment Precautions
- 5 Operating Parameters

### **Terumo® Advanced Perfusion System 1**

- 6 Installation
- 6 Connect ABD Module
- 6 Connect ABD Sensor
- 7 Enabling and Disabling Air Detection Alarms
- 8 Test Before Use
- 8 Air Bubble Detection Messages
- 9 Clean and Check After Each Use
- 9 Service

### **Sarns™ Modular Perfusion System 8000**

- 9 Installation
- 10 Select Sensor and Determine Proper Position
- 10 Test Before Use
- 11 Devise an Air Venting Method
- 11 Respond to Alarms Immediately
- 12 Clean and Check After Each Use
- 12 Service

### **Limited Warranty**

# Description

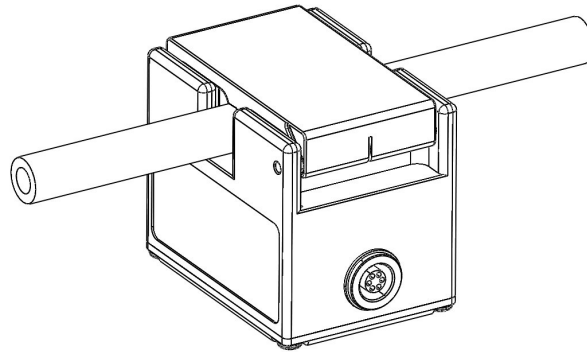

Terumo® Ultrasonic Air Sensors are compatible with these systems:

- Terumo® Advanced Perfusion System 1
- Sarns™ Modular Perfusion System 8000

The Ultrasonic Air Sensor is available in several styles, each for a specific tubing size and flow rate. Each sensor is color-coded and marked for the correct tubing size. An acoustical couplant (gel) is not required nor recommended for these sensors.

The air sensor size and weight allow it to mount directly on the tubing. The air sensor measures 2.8 in. (7,1 cm) long by 2.1 (5,4 cm) high by 1.9 in. (4,7 cm) wide and it weighs 0.48 lbs (0.22 kg). The air sensor cable weighs 0.38 lbs (0.17 kg). An optional bracket is available to mount the air sensor on a pole.

When properly clamped around a blood line, the Ultrasonic Air Sensor emits an ultrasonic signal through the tubing to detect gross air bubbles in clear fluid or blood. With no air, most of the transmitted signal passes through the fluid. If the ultrasonic beam is interrupted by air, the controls trigger an alarm that causes a connected pump to execute a user configured response.

System 1 and Modular Perfusion System 8000 may be set so that an air detection alarm will stop both the arterial and cardioplegia pumps.

## Indications

The Terumo® Ultrasonic Air Sensors are intended for use with Terumo and Sarns brand air detection and heart-lung systems to detect gross air bubbles in the line during extracorporeal procedures.

## Contraindications

The Ultrasonic Air Sensors are not designed, sold, or intended for use except as indicated.

## User Qualifications

Proper surgical procedures and techniques are the responsibility of the medical professional.

User must read and understand all information in the operators manual for the device being used.

## Warnings

Use the system and any attached equipment according to the manufacturer's instructions and good medical practice.

Do not use an apparently malfunctioning device in an operation.

The air sensor latch must be completely closed to secure the sensor to the tubing.

# Description

Air Detection must be properly set up and turned ON as UNDETECTED AIR in the line may cause gaseous emboli to be pumped into the patient, with attendant risk of death or severe bodily injury. The performance of the air detection must be verified before each use. If the Air Detection is turned off, constant monitoring is required to reduce the risk of air embolism in the line.

The air sensor may not detect air bubbles smaller than the minimum size specified for the air sensor to be used.

The air sensors must be used with the appropriate tubing size and within the flow rate limitations specified for the air sensor or the air sensor may not detect air bubbles (see Operating Parameters).

If the pump section of the tubeset is larger than the air sensor section, it may be possible to exceed the maximum flow rate at which the Air Sensor will detect bubbles.

The air sensor must be positioned a minimum of 4 ft. (1,2 m) from the patient to allow the air detection system sufficient time to stop the pump before air can reach the patient.

The air sensor may falsely alarm with intense electrical noise.

See additional warnings in "Installation" for specific systems.

## Equipment Precautions

Do not drop the ultrasonic air sensor as shock may damage the sensor.

Do not sterilize the air sensors as sterilization may damage the sensors.

## Operating Parameters

### Tubing Requirements

Clear, flexible medical grade PVC tubing.  
Tubing size must match size indicated on sensor.

### Performance

Sensor 5773 detects air bubbles within clear flexible medical grade PVC tubing with clear priming solutions or blood with hematocrit from 15% to 40% at ambient temperatures from 10-40 °C.

Sensors 5785 and 5791 detect air bubbles within clear flexible medical grade PVC tubing with clear priming solutions or blood with hematocrit from 15% to 40% at ambient temperatures from 10-40 °C.

Sensor 5785 for 1/4 in. (6,4 mm) ID x 1/16 in. (1,6 mm) wall tubing will detect bubbles of 0.3 cc or larger at flow rates up to 3.0 L/Min. It may detect bubbles from 0.05 cc - 0.3 cc depending on operating conditions.

Sensor 5791 for 1/4 in. (6,4 mm) ID x 3/32 in. (2,4 mm) wall tubing will detect bubbles of 0.3 cc or larger at flow rates up to 3.0 L/Min. It may detect bubbles from 0.05 cc - 0.3 cc depending on operating conditions.

Sensor 5773 for 3/8 in. (9.5 mm) ID x 3/32 in. (2,4 mm) wall tubing will detect bubbles of 0.5 cc or larger at flow rates up to 6.0 L/Min. It may detect bubbles from 0.1 cc - 0.5 cc depending on operating conditions.

**WARNINGS:** The air sensor may not detect air bubbles smaller than the minimum size specified for the air sensor to be used. The air sensors must be used with the appropriate tubing size and within the flow rate limitations specified for the air sensor or the air sensor may not detect air bubbles (see Operating Parameters).

# Terumo® Advanced Perfusion System 1

See the operators manual for the Terumo® Advanced Perfusion System1 regarding air detection controls, configuration of safety connections and general system information

## Installation

**WARNINGS:** The level detection and air bubble detection systems must be properly set up and turned ON as UNDETECTED AIR in the line may cause gaseous emboli to be pumped into the patient, with attendant risk of DEATH OR SEVERE INJURY. The performance of the level and air detection must be verified before each use.

**WARNINGS:** If an air or level detection system is turned OFF or is configured not to stop a pump, then constant monitoring is required to reduce the risk of air embolism in the line.

**WARNINGS:** If the cardioplegia pump is drawing blood from the arterial line, stop the cardioplegia pump whenever the arterial pump is stopped to avoid infusion of air.

## Connect ABD Module

1. Select the sensor which is appropriate for the tubing size to be used.

**WARNING:** The air sensor may not detect air bubbles smaller than the minimum size specified for the air sensor used. The air sensor must be used with the appropriate tubing size and within the flow rate limitations specified for the air sensor or the air sensor may not detect air bubbles.

2. Ensure the sensor is clean, free of debris, and undamaged.
3. Align red dots on the sensor cable and module receptacle and insert cable into module. Pull gently to check the connection.
4. Insert ABD module into base receptacle as close as possible to the location where the sensor will be used. Arrange cables to minimize exposure to spills.

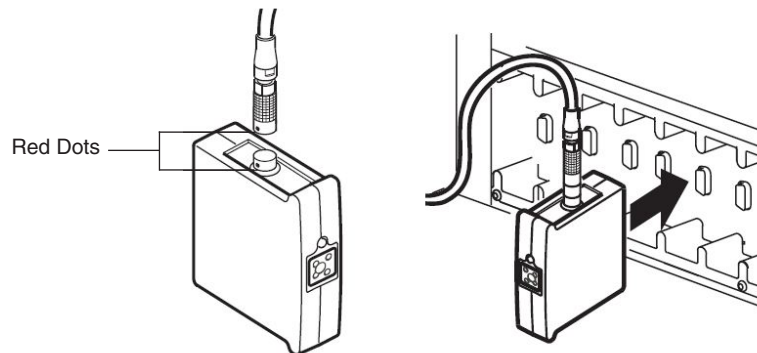

## Connect Air Sensor

The air sensor size and weight allow it to mount directly on the tubing. However, the sensor can be mounted on a bracket to provide added stability and is recommended for 1/4 in. tubing.

**CAUTIONS:** Do not drop air, level, or flow sensors as shock may damage the sensor.  
Do not sterilize air, level, or flow sensors as sterilization may damage the sensor.

Attach mounting bracket to pole, if desired.

Determine proper position within perfusion circuit.

**WARNINGS:** The air sensor must be positioned a minimum of 4 ft. (1,2 m) from the patient to allow the air bubble detection system sufficient time to respond before air can reach the patient.

**WARNINGS:** The air sensor latch must be completely closed to secure the sensor to the tubing.

**WARNINGS:** The air sensor may falsely alarm with intense electrical noise.

# Terumo® Advanced Perfusion System 1

- Proper positioning of the air sensor is the choice of the medical professional.
  - The air sensor must be positioned so there will be sufficient time to stop the pump and vent air bubbles before reaching the patient.
  - High flow rate, differences in circuit configuration, and changing conditions of operation can cause air bubbles to travel 4 ft. (1,2 m) when the pump stops. Air bubbles may then move to a higher point in the circuit.
1. If necessary, use reducing connectors to adapt the tubing section so that the appropriate size of tubing can be placed into the air sensor.
  2. Open the sensor by pushing up on the bottom of the latch and slide latch off the door bracket.
  3. Insert tubing.
  4. Close and latch the sensor door to secure the sensor around the tube. Do not apply gel, as acoustical couplant is not required nor recommended for the sensor.
  5. If desired, connect the sensor to the bracket. The air sensor may be mounted directly on the tubing, provided the weight of the sensor does not kink or stress the tube.
- Do not position the sensor upside down (cover toward floor) as bubbles may go undetected.

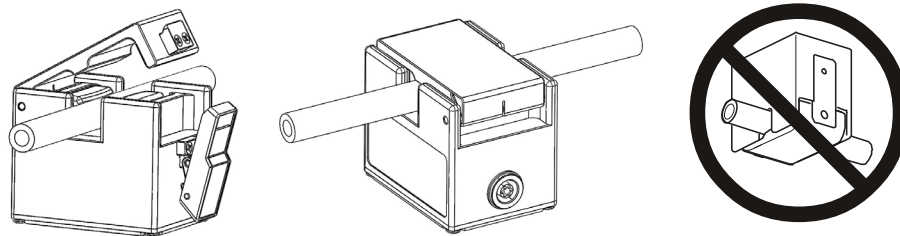

## Enabling, Resetting, or Disabling Air Bubble Detection Alarms

Select the **Air** subtab within the Safety tab on the Perfusion Screen or touch the **Air** icon on the CCM.

1. Touch the air detection **On** button to enable the alarm capability for the air detection system and the icon on the CCM turns green.
2. Touch the air detection **Off** button to disable the alarm capability for the air detection system and the icon on the CCM turns gray.

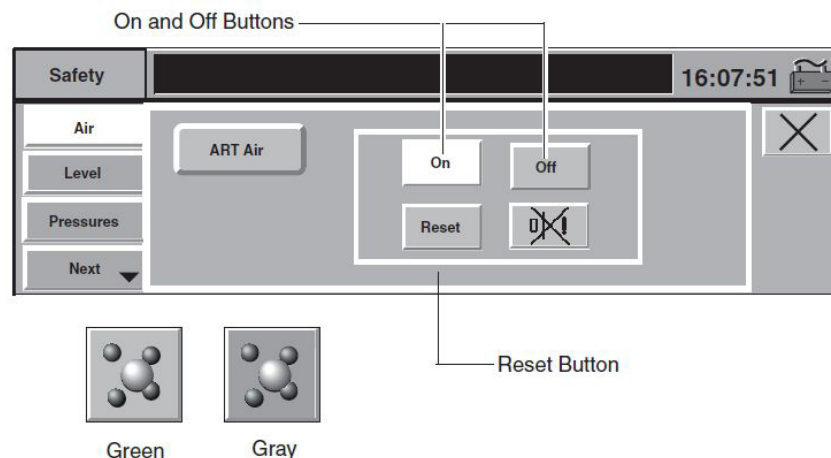

3. When air is detected, correct the condition, and then touch the **Reset** button on the CCM to clear an air alarm and leave the air bubble detector enabled. If an air bubble detector has a safety connection to a pump, the alarm can also be reset by touching the **Select** button on the pump control panel after the air has been cleared. The ABD is the only safety device that requires a reset by the user to confirm that the issue has been addressed. All other safety devices automatically reset when the issue is resolved.

# Terumo® Advanced Perfusion System 1

## System Response to Air Bubble Detection Alarm

Air Icon	Air Module	Message	Connected Device(s)	Audible Tone
Flashes red	LED flashes red	Message with sensor name in the CCM message area and on the local display of any pumps with an air safety connection. Safety tab opens.	Respond as configured	Dual-tone alarm

The alarm state will clear when the condition is corrected and the air bubble detection system is Reset or turned Off.

Note: The ABD system will alarm when the air sensor is disconnected from the module.

## Test Before Use

The performance of every air bubble detection system must be verified before each use.

Action	Results
Make necessary safety connections. This is done in the Configuration Screen. Refer to CCM chapter Configuration section for details.	
Air bubble detection system is off; sensor does not contain tubing. Start pump(s). Adjust speed.	Air icon is gray. Module LED is green. Pumps start because air detection system is off.
Turn air bubble detection system on.	Pumps should respond as they were configured and message will display on the pump display. Air icon flashes red. Air detect message appears in the message area of the CCM and the air module LED flashes red. Dual-tone alarm sounds.
Insert tubing containing clear fluid or blood into sensor; touch reset on the CCM or press Select on the pump control panel. Start pump(s) if stopped. Adjust speed.	Air message clears from pump display and CCM Air icon and module LED turn green. Pump(s) start.

## Air Bubble Detection Messages

Priority	Condition	CCM Message	Operator Response
Alarm	Air detected	<ABD name>: AIR DETECTED	Correct air condition, reset air sensor, restart pump if stopped.
	Air detected	AIR DETECTED: <Pump Name> <Pump Response>	Correct air condition, reset air sensor, restart pump if stopped.
	Air sensor on and disconnected	<ABD name>: AIR DETECTED	Reconnect air sensor, reset air sensor, restart pump if stopped.
Alert	Air sensor malfunction	<ABD name>: CHECK SENSOR	Check air sensor cable connections. Reset air sensor. If message does not clear, replace air sensor.

# Terumo® Advanced Perfusion System 1

## Clean and Check After Each Use

### Clean air sensors

Clean with mild soap and water solution. Do not use any sharp instruments or abrasive materials.

Do not drop the sensors as shock may damage them.

Wipe transducer of air sensor. Do not immerse air sensor. Between cases store the air sensor on the bracket.

Do not sterilize the air sensors as this will damage the sensor.

If a sensor is damaged, contact Terumo Cardiovascular Systems Corporation Service.

## Service

It is recommended that the bubble detection system, including the Ultrasonic Air Sensor, have a maintenance inspection every six months to ensure proper operation. Maintenance inspections and repairs must be conducted by Terumo Cardiovascular Systems Corporation certified service technicians.

# Sarns™ Modular Perfusion System 8000

See the Operators Manual for the Modular Perfusion System 8000 regarding air detection controls, connection of the Safety Monitor to the system and general system information.

## Installation

- Secure the Sarns™ Bracket for Ultrasonic Air Sensors 5793 to a pole, if desired.
- Plug the Air Sensor cable into the sensor and into the air detection connection on the 8000 Safety Module.

Align the red dot of the 6-pin Lemo\* connector with the dot on the receptacle and insert the cable. Pull gently to check this connection. To disconnect, grasp the Lemo connector near the red dot and pull.

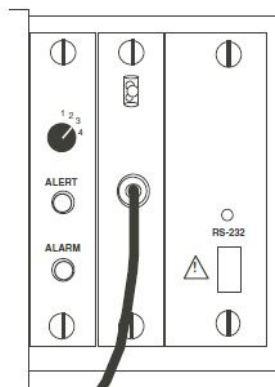

Electronic Modules on the 8000 Safety Monitor.

\*Lemo USA Inc., Santa Rosa, CA.

# Sarns™ Modular Perfusion System 8000

## Select Sensor and Determine Proper Position

**WARNING:** The air sensors must be used with the appropriate tubing size and within the flow rate limitations specified for the air sensor or the air sensor may not detect air bubbles (see Operating Parameters).

1. Select the sensor which is appropriate for the tubing size and flow rate to be used. See that the transducer is clean, free of foreign debris and undamaged.
2. Determine the proper position.

**WARNING:** The air sensor must be positioned a minimum of 4 ft. (1,2 m) from the patient to allow the air detection system sufficient time to stop the pump before air can reach the patient.

Proper positioning of the air sensor is ultimately up to the medical professional. The air sensor must be positioned so there will be sufficient time to stop and vent any air bubbles before reaching the patient. High flow rates, differences in circuit configuration, and changing conditions of operation can cause bubbles to travel beyond 4 ft (1,2 m) length when the pump stops; air bubbles may then move to a higher point in the circuit.

Note: Although massive air will deprime a centrifugal pump, small amounts of air will be temporarily trapped in the pump chamber and then passed to the arterial line in the form of micro-bubbles. The medical professional may wish to position the sensor proximal to the centrifugal pump when confident that air will not enter the extracorporeal circuit distal to the centrifugal pump.

3. Insert the tubing.

**WARNINGS:** If the pump section of the tubeset is larger than the air sensor section, it may be possible to exceed the maximum flow rate at which the Air Sensor will detect bubbles.

The air sensor latch must be completely closed to secure the sensor to the tubing.

- If necessary, use reducing connectors to adapt the arterial tubing section so that the appropriate size of tubing will be placed into the air sensor.
- Open the sensor by pushing up on the bottom of the latch, insert the tubing, and close the latch to secure the sensor around the line. Do not apply any gel as acoustical couplant is not required nor recommended for this sensor.
- If desired, mount the sensor to the pole mount bracket. The air sensor may be mounted directly on the tubing, provided that the weight of the sensor does not kink or stress the line.

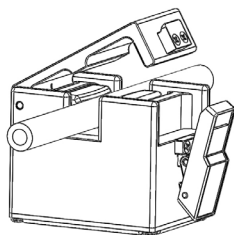

Push up on bottom of latch.

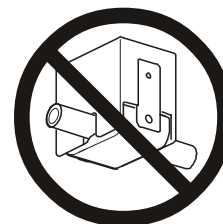

Do not position the sensor upside-down (cover toward floor) as bubbles may go undetected.

Insert Tubing

# Sarns™ Modular Perfusion System 8000

## Test Before Use

**WARNINGS:** Air Detection must be properly set up and turned ON as UNDETECTED AIR in the line may cause gaseous emboli to be pumped into the patient, with attendant risk of death or severe bodily injury. The performance of the air detection must be verified before each use. If the Air Detection is turned off, constant monitoring is required to reduce the risk of air embolism in the line.

Avoid unintentionally stopping the arterial and cardioplegia pumps by resolving any air conditions until the red bar light is completely off and by pressing RESET before pressing the air detection switch ON.

Action	8000 System
Connect arterial and cardioplegia stop lines to these pumps; connect safety cable to monitor.	
Detection is OFF; sensor does not contain tubing.	OFF switch yellow LED is lighted.
Start the arterial and cardioplegia pumps in forward mode.	1/8 of red indicator bar lights. Pumps start as detection is off.
Press air detection ON.	Entire red indicator bar flashes. Audible alarm sounds. Arterial and cardioplegia pumps stop.
Insert tubing containing clear fluid or blood into the sensor; press RESET for at least one second and release to clear prior conditions. Press Forward switches on pumps; adjust speed knob.	All lights on the red indicator bar go off. Audio alarm ceases. ON switch indicator lights green. Pumps start.

Should the air detection alarm falsely or fail to alarm, correct any problems (see the warning above); test until assured that air detection is functioning correctly. Once primed and tested, the pump and air detection may be left on.

## Devise an Air Venting Method

Be prepared to remove bubbles from any point in the tubing at which they may stop. The operator must devise a fast and reliable method for venting air detected by the Air Sensor. Two possible methods are to vent the air from a Luer lock or trap the air in an alternate section of tubing. The operator should determine the best technique for removing bubbles from the system, and practice that technique until certain of its safety and effectiveness.

If Centrifugal Pump Stops When Air Bubble Detector is on Arterial Line

When the air bubble detector stops a centrifugal pump, clamp both the arterial and venous lines; then unclamp the arterial line and let backflow purge air to the reservoir. If necessary, reclamp the arterial line, remove the pump from the motor, and tip and tap the pump to remove the air. Remove any air from the entire arterial line before resetting the air bubble detector.

False Alarms

When activated, unshielded electrical equipment elsewhere in the operating room (particularly defibrillators and electrocautery devices) may cause a false alarm (automatically shutting off the arterial pump), it is the operator's responsibility to decide whether to turn off the Air Detector to avoid a false alarm.

**WARNING:** The air sensor may alarm falsely with intense electrical noise.

## Respond to Alarms Immediately

8000 Alarm Condition	Operator Response
An air bubble is detected or air sensor is disconnected. The arterial and cardioplegia pumps will be stopped.	For centrifugal pump, clamp arterial and venous lines immediately and then remove the air. Remove air from the blood line or correct the source of a false alarm. Reset to clear alarm. Start the pumps again.

# Sarns™ Modular Perfusion System 8000

## Clean and Check After Each Use

**PRECAUTIONS:** Do not drop the ultrasonic air sensor as the crystals may break, thus compromising alarm detection ability. Do not sterilize the air sensors with heat or gas as this will damage the sensors.

Between cases, store the air sensor on the sensor holder. Whenever necessary, clean the transducers by wiping it clean with mild soap and water solution. Do not use any sharp instruments or abrasive materials as they will damage the transducer; do not immerse the sensor. If the sensor is damaged, contact Terumo Cardiovascular Systems Corporation Service.

## Service

It is recommended that the bubble detection system, including the Ultrasonic Air Sensor, have a maintenance inspection every six months to ensure proper operation. Maintenance inspections and repairs must be conducted by Terumo Cardiovascular Systems Corporation certified service technicians.

## Limited Warranty

Terumo Cardiovascular Systems Corporation warrants that this product will be free from defects in workmanship or material for one year from the date of shipment. This warranty does not apply to filters, light bulbs, fuses, or other expendable items, or to those parts damaged by improper use, accident, improper maintenance or unauthorized repair.

THIS WARRANTY IS MADE IN LIEU OF ALL OTHER WARRANTIES, EXPRESS OR IMPLIED, INCLUDING ANY IMPLIED WARRANTY OF MERCHANTABILITY OR FITNESS FOR A PARTICULAR PURPOSE.

### Limitation of Remedies

As your exclusive remedy under this warranty, Terumo Cardiovascular Systems Corporation will repair or replace free of charge, or at Terumo Cardiovascular Systems Corporation's option, return the purchase price of, any part or unit found to be defective in workmanship or material during one full year from the date of shipment.

Terumo Cardiovascular Systems Corporation shall not be liable under any circumstances for any consequential, incidental or indirect damages or expenses associated with this product or its use. This exclusion does not apply to claims for personal injury by a third party.

### Customers

If a warranty condition develops, contact Terumo Cardiovascular Systems Corporation Service, or your authorized distributor. This warranty gives you specific legal rights; you may have other rights as well, which vary from state to state in the U.S.A.

In the United States, contact the Service Department:

Terumo Cardiovascular Systems Corporation  
6200 Jackson Road  
Ann Arbor, Michigan 48103 U.S.A.  
Telephone: (734) 663-4145 (800) 521-2818  
Facsimile: (734) 741-6449







Outside the United States, please contact your authorized Terumo Cardiovascular Systems Corporation distributor regarding local warranty conditions or contact the Technical Support Department at Terumo Cardiovascular Systems Corporation:





Telephone: (734) 663-4145  
Facsimile: (734) 741-6449

Note: All returned goods must have a Returned Goods (RG) number prior to return.

# Symbols Glossary

The following symbols may appear in the labeling, marking, or display of the Terumo Cardiovascular Systems (TCVS) Air Bubble Detection System. These symbols are in accordance with the internationally harmonized standards.

Symbol	Title	Description	Source
	Consult instructions for use.	Indicates the need for the user to consult the instructions for use.	ISO 15223-1-5.4.3
	Caution	Indicates the need for the user to consult the instructions for use for important cautionary information such as warnings and precautions that cannot, for a variety of reasons, be presented on the medical device itself.	ISO 15223-1-5.4.4
	Serial number	Indicates the manufacturer's serial number so that a specific medical device can be identified	ISO 15223-1-5.1.7
	Manufacturer	Indicates the medical device manufacturer, as defined in EU Directives 90/385/EEC, 93/42/EEC and 98/79/EC	ISO 15223-1-5.1.1
	Keep dry	Indicates a medical device that needs to be protected from moisture.	ISO 15223-1-5.3.4
	Date of manufacture.	Indicates the date when the medical device was manufactured.	ISO 15223-1-5.1.3
	Number of contents in carton.	Identifies the number of contents	Terumo Cardiovascular Systems

	Catalogue Number	Indicates the manufacturer's catalogue number so that the medical device can be identified	ISO 15223-1-5.1.6
	Authorized representative in the European Community	Indicates the Authorized representative in the European Community	ISO 15223-1-5.1.2
	WEEE	This standard applies to Electronic equipment in accordance with article 11(12) of Directive 2002/96/EC	Directive 2002/96/EC
<b>Rx ONLY</b>	Prescription only	Caution: Federal (U.S.A.) law restricts this device to sale, distribution and use by or on the order of a physician	21 CFR 801.109
	Do not turn upside down	Indicates not to turn the UAS upside down	Terumo Cardiovascular Systems

Standards:

ISO 15223-1: Medical devices — Symbols to be used with medical device labels, labelling and information to be supplied Part 1: General Requirements



Product of US



**Terumo Cardiovascular Systems Corporation**

6200 Jackson Road, Ann Arbor, Michigan 48103-9300  
(734) 663-4145 (800) 521-2818



**Terumo Europe N.V.**

Interleuvenlaan 40  
3001 Leuven, Belgium

**Terumo Australia Pty Ltd**

Macquarie Park NSW 2113 Australia

**Terumo Corporation**

44-1, 2-Chome, Hatagaya, Shibuya-ku,  
Tokyo 151-0072, Japan

90000003 R/C  
May, 2021